



Open Aggregation Routers

Jeff Catlin V.P. Technology Edgecore Networks

- Edgecore Cell Site Gateway Router Contribution
- Edgecore Aggregation Router Contribution
- Q&A

Active members in Open Compute since 2013 !

- #1 Network ODM
- Founded 1988, IPO Taiwan 1995
- Engineering: 700 network engineers
- Manufacturing: Accton in Taiwan & China. Partners. TAA Compliant

Accton

Total: 3,750 employees worldwide

- Wholly owned subsidiary of Accton
- Go-to-market organization to network operators
- Manages customer, partner and open community relationships

Why “Open” Cell Site Gateways?

- Updates to existing equipment is needed as mobile backhaul usage surges with 5G deployments on the horizon. Sitting at the edge of the network the Cell Site Gateway is high volume deployment product and a natural location for Carriers to start enjoying the benefits of open networking.
 - Removal of single vendor lock in and traditionally slow technology roadmaps from incumbents
 - Truly open Hardware that can run different commercial and open source operating systems offering freedom of choice to the operator
 - New operating systems choices that provide extensibility and the execution of arbitrary agents
 - Removal of vendor lock in on pluggable optics and cables leading to lower capex

Cell Site Gateway High Level Requirements

- Outside plant compliant with operating temperature -40C to +65C
- 1RU 19" Rack mountable
- Maximum equipment depth 300mm
- Redundant power supplies and fans
- Support clock synchronization techniques incl IEEE 1588 and SyncE
- Support for local timing inputs/outputs GPS, ToD, 1PPM, etc.
- Ability to support long haul optical modules

Topology

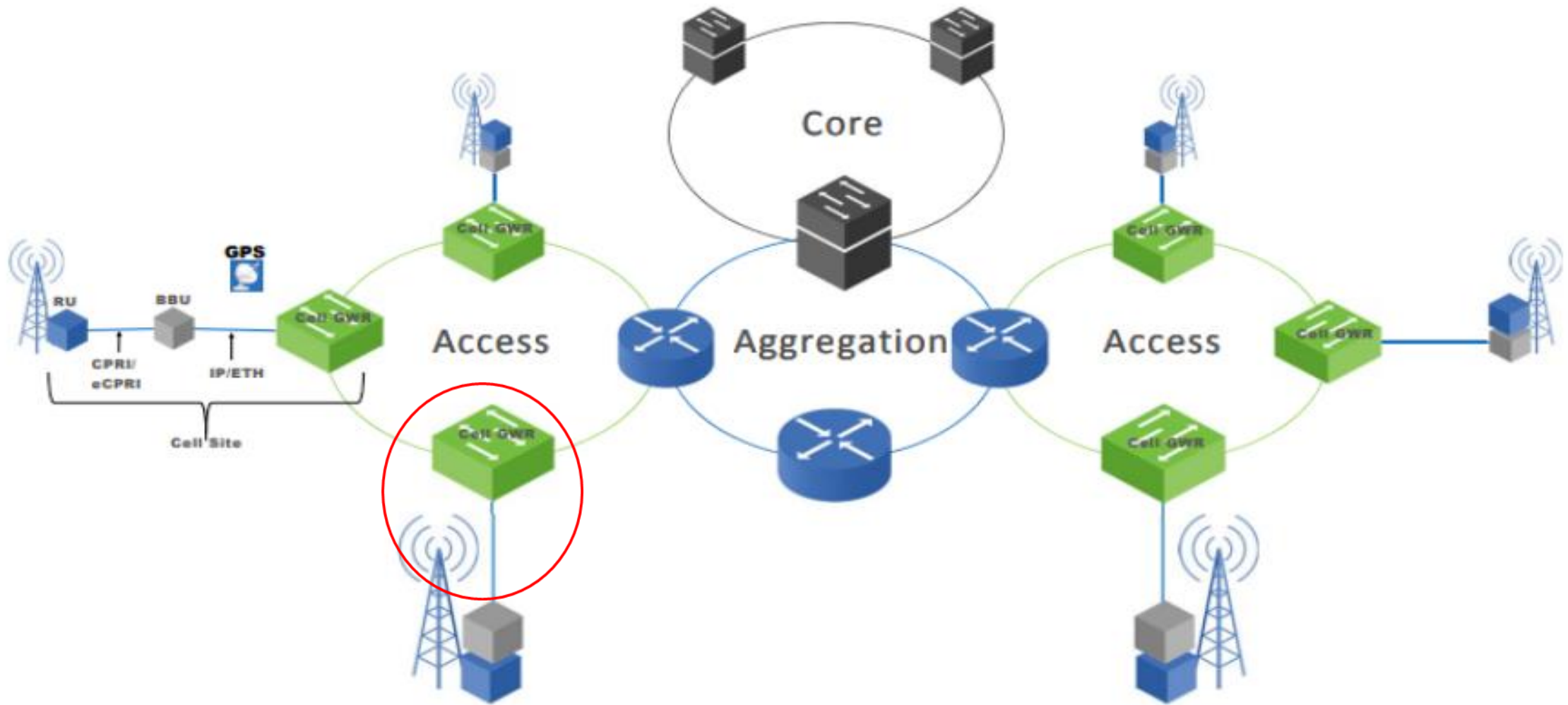

Source: AT&T OCP Presentation OCP_OutDoorSIAD.V4.pdf

- Conforms to the AT&T Cell Site Gateway Router Specification
- 16 x 10G SFP+, 8 x 25G QSFP28, 2 x 100G QSFP28
- Deep Buffer Switch Architecture
- Outdoor Plant Deployment
 - NEBS 3, -40 to 65C operating temp
 - 1U, 300mm depth
 - 350W max power
- Full 1588 and Synchronous Ethernet
- AC and 48VDC Power Options
- Broadcom StrataDNX QumranAX silicon

metaswitch ipinfusion™

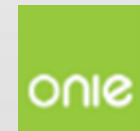

Edgecore AS7316-26XB Cell Site Gateway

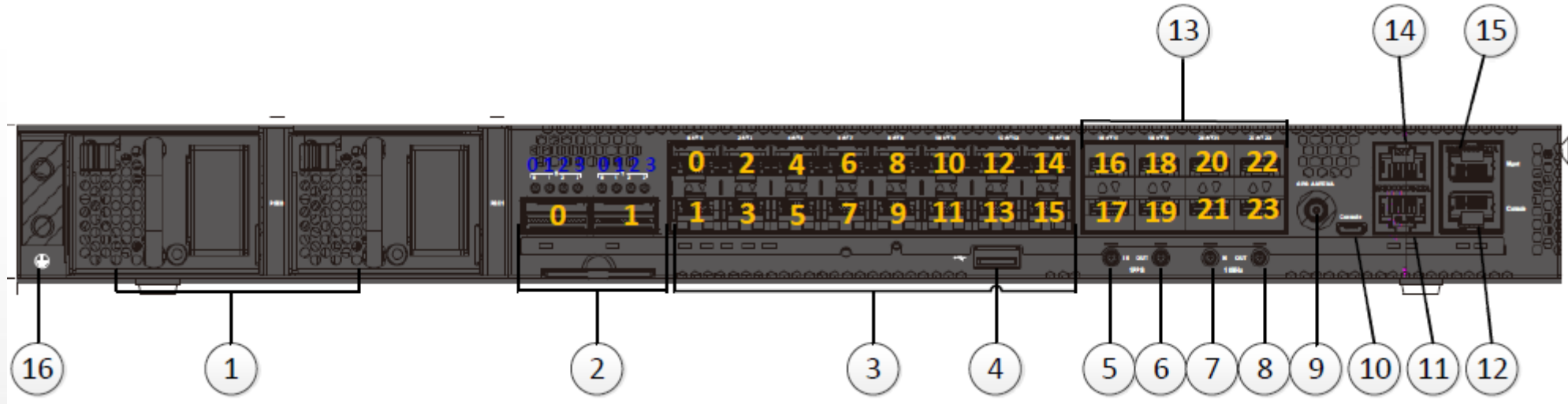

Description	
1- Power Supplies	9- GPS antenna port
2-100 Gigabit Ethernet QSFP28 ports	10-Micro USB console port
3-10 Gigabit Ethernet SFP+ ports	11-Time of day (ToD) RJ45 port
4-USB storage port	12-RJ45 console port
5-1PPS input port	13-25 Gigabit Ethernet SFP28 ports
6-1PPS output port	14- Building-Integrated Timing System port (BITS)
7-10MHz input port	15-Management Ethernet port (MGMT)
8-10MHz output port	16-Grounding mark

Edgecore AS7316-26XB Cell Site Gateway

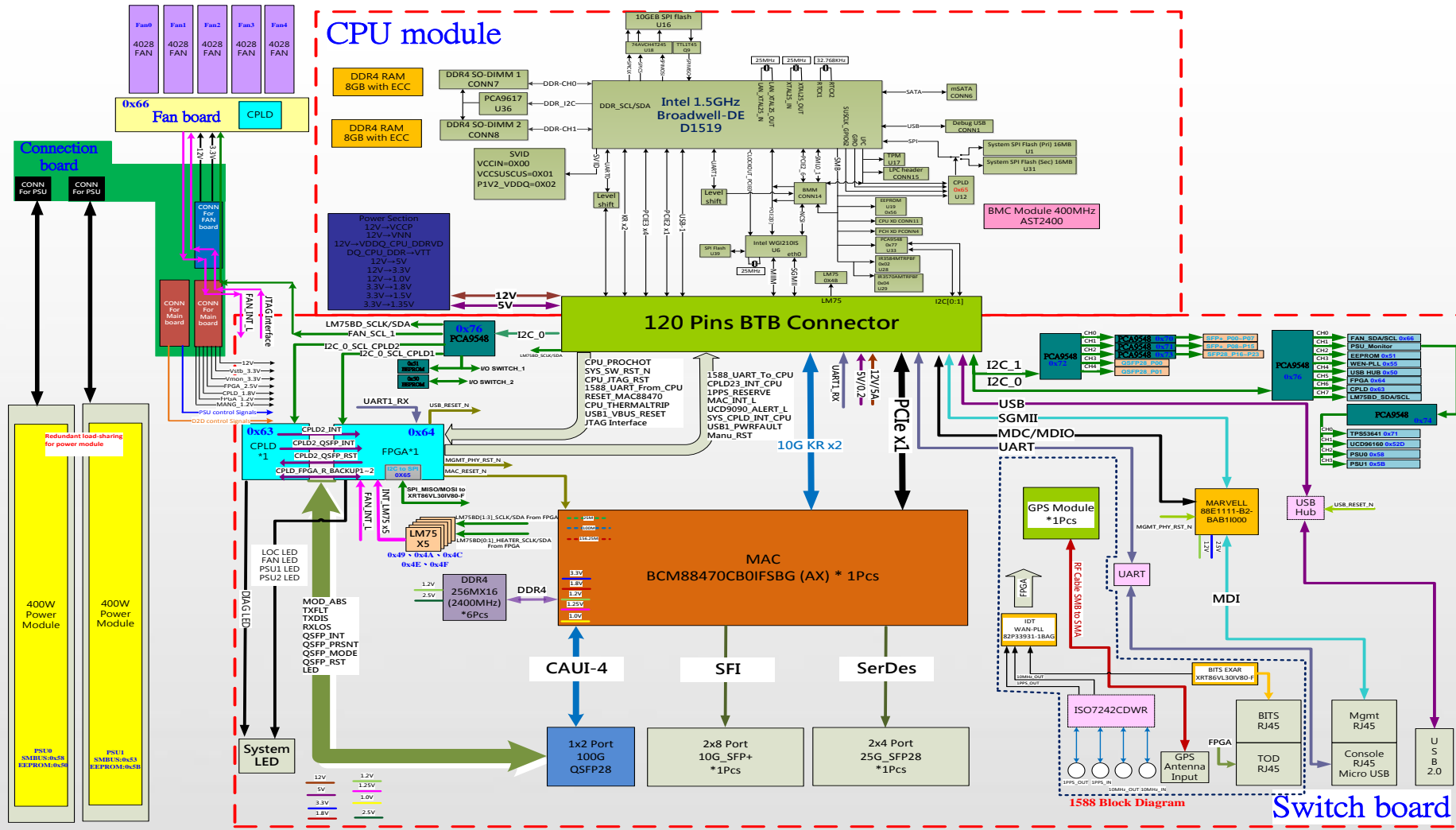

- Included in the Edgecore AS7316-26XB contribution
 - Hardware specification
 - Software programming guide
 - Schematics
 - Gerber files
 - Allegro .brd files
 - Mechanical STEP files
 - CPLD code in source and binary format
 - Test plan

- Contribution Schedule
 - Specification contribution – Complete ready for review
 - Design file contribution – Complete ready for review
 - Incubation Committee overview and presentation – Complete
 - Contribution Acceptance - Tentative completion by early November
- Product Schedule
 - Sample units distributed to software partners – Complete
 - PoC tests and filed trials – Throughout Q4 2018
 - Volume and GA Q1 2019

Topology

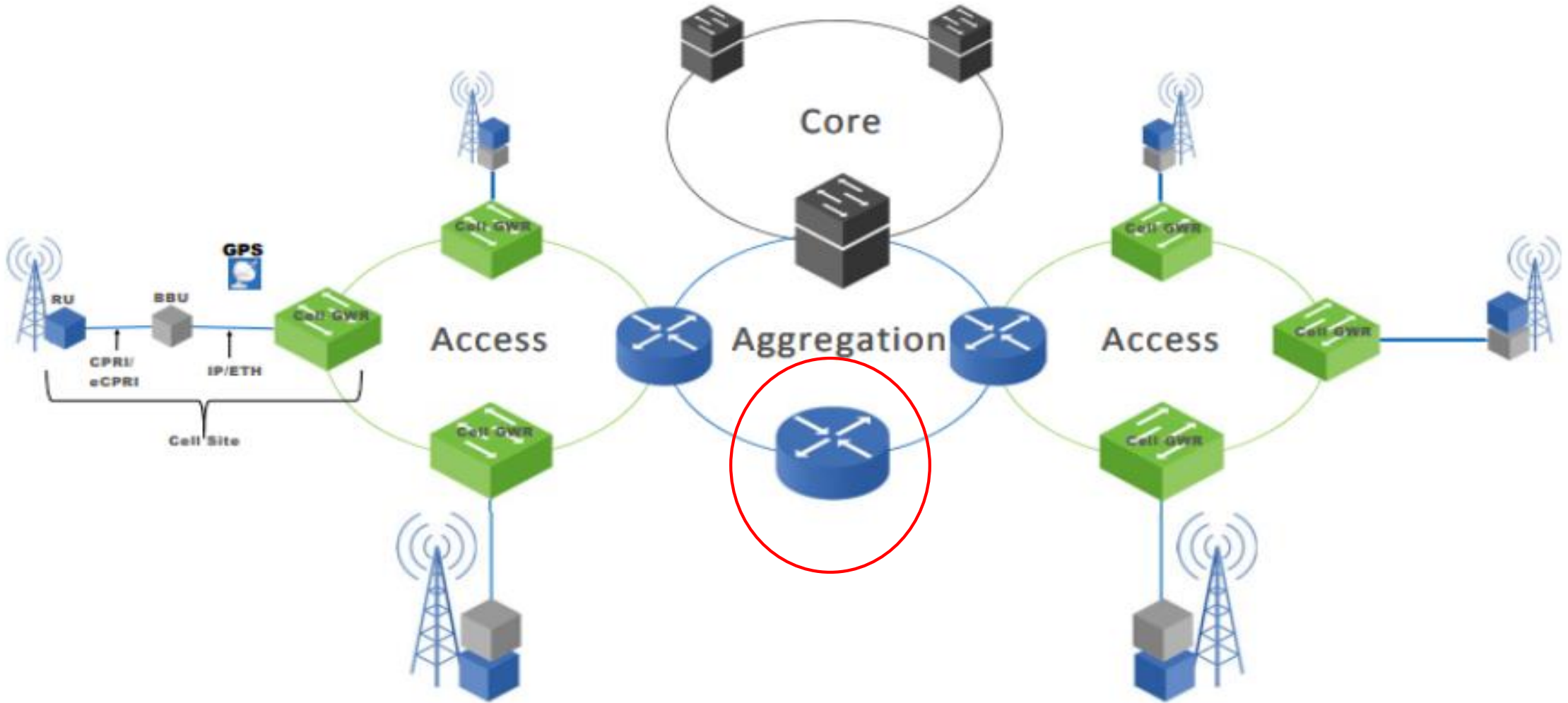

Source: AT&T OCP Presentation OCP_OutDoorSIAD.V4.pdf

Why “Open” Aggregation Routers?

Increasing cellular deployments and upcoming new 5G deployments may/will necessitate updates to the aggregation network

- Removal of single vendor lock in and traditionally slow technology roadmaps from incumbents
- Truly open Hardware that can run different commercial and open source operating systems offering freedom of choice to the operator
- New operating systems choices that provide extensibility and the execution of arbitrary agents
- Removal of vendor lock in on pluggable optics and cables leading to lower capex

- 19" Rack mountable
- Redundant power supplies and fans
- Support clock synchronization techniques incl IEEE 1588 and SyncE
- High density 100G connections
- Support for 400G connections
- Deep Buffering
- Large Capacity TCAM
- Ability to support long haul optical modules

Edgecore AS7926-40XK, -80XK Aggregation Routers



- 40 x 100G and 80 x 100G models
- Broadcom StrataDNX Jericho 2 (BCM88690)
- Deep Buffer Switch
- Expandable TCAM (BCM16K)
- IEEE 1588 and Synchronous Ethernet
- AC and 48VDC Power Options
- “Building Block Design” for future offerings

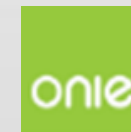

Edgecore AS7926-40XK, -80XK Building Blocks

2 RU Design: 40x100G

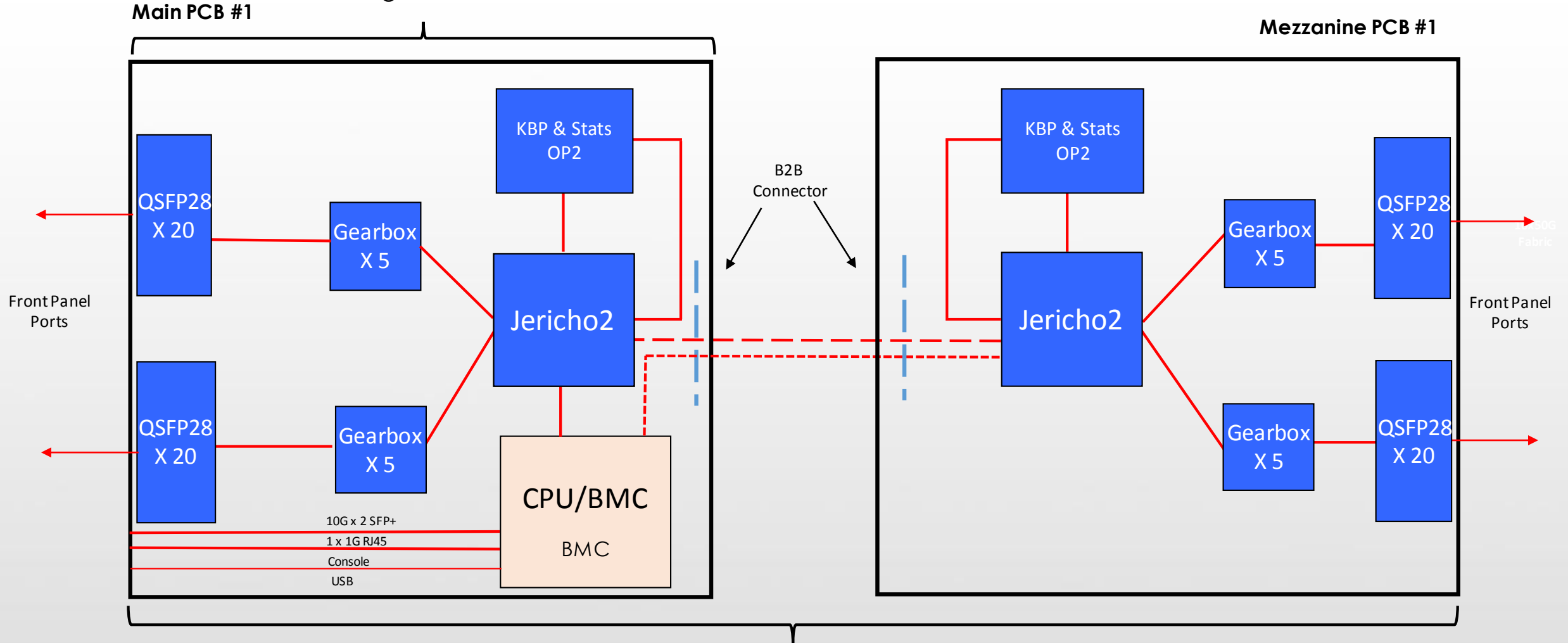

3 RU Design: 80x100G

- Contribution Schedule
 - Specification contribution – Complete - Ready for review and feedback
 - Design package contribution – After specification review – Target Q4 2018
- Product Schedule
 - Sample units distributed to software partners – October 2018
 - PoC tests and field trials – throughout Q1 2019
 - Volume and GA late Q1 2019

What's Next Aggregation Router Designs?

- There is plenty of innovation still left to do !
- 400G Mezzanine card for mixture of 100G and 400G
- 400G Main PCB for complete 400G solutions
- Distributed chassis designs
- ...?

Follow up!

- Purchase these and other products on the OCP Marketplace!

<https://www.opencompute.org/products>

- Download detailed specifications from the Telco group wiki !

https://www.opencompute.org/wiki/Telcos#Specs_and_Designs

- Provide feedback and ideas to mailing list !

<https://www.opencompute.org/projects/telco>

THANK
YOU